

Custom High Performance Cooling Solutions w/ maxiGRIP™ Attachment*

DIGI-KEY PART # **ATS1367-ND**

ATS PART # ATS-59002-C2-R0

Features & Benefits

Designed for flip-chip processors such as Freescale MPCs

maxiGRIP™ attachment applies steady, even pressure to the component and does not require holes in the PCB

Comes preassembled with high performance, phase changing, thermal interface material

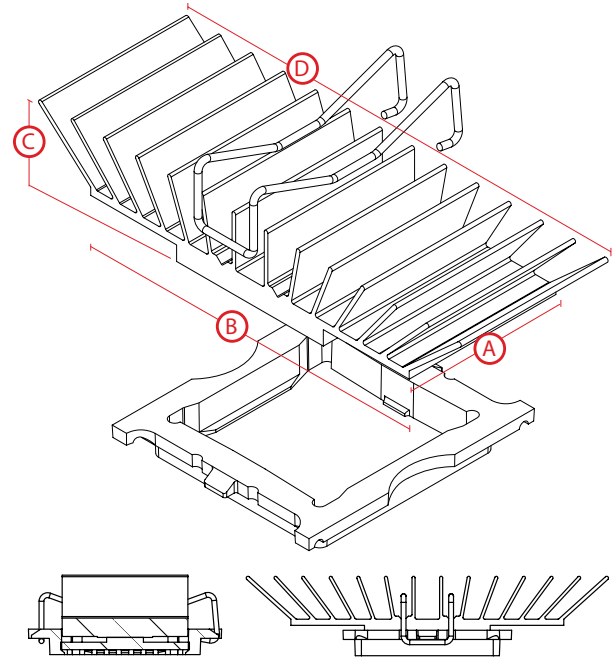

Thermal Performance Table

AIR VELOCITY		THERMAL RESISTANCE	
FT/MIN	M/S	°C/W (UNDUCTED)	°C/W (DUCTED)
200	1.0	6.5	3.8
300	1.5	5	
400	2.0	4.1	
500	2.5	3.6	
600	3.0	3.2	
700	3.5	3	
800	4.0	2.7	

Product Details†

DIMENSION A	DIMENSION B	DIMENSION C§	DIMENSION D	TIM†	FINISH
25	32	13	46.5	C1100F	BLACK-ANODIZED

For further technical information, please contact Advanced Thermal Solutions, Inc. at **1-781-769-2800** or www.qats.com

* RoHS Compliant

† TIM = Thermal Interface Material

‡ Dimensions are measured in millimeters

§ Dimension C = the height of the heat sink shown above and does not include the height of the attachment method



ATS ADVANCED THERMAL SOLUTIONS, INC.

Innovations in Thermal Management®



To place an order, please visit www.digikey.com